

PRICE LIST

September 2024 - Version 2.4



Glass Rooms
Alfresco Verandas
Carports
Canopies
Aluminium Fencing
Shading



Contents

The Alfresco Range

<i>The Contemporary Alfresco</i>	4
----------------------------------	----------

The Simplicity Range

<i>The Simplicity Xtra</i>	5
<i>The Simplicity 6</i>	6
<i>The Simplicity 16</i>	7
<i>The Simplicity 35</i>	8
<i>The Simplicity Free (Mono)</i>	9
<i>The Simplicity Free (Apex)</i>	10
<i>Privacy Screens</i>	11

Aluminium Fencing

<i>A-Fence</i>	12-15
----------------	--------------

Non-Standard RAL Colours

<i>RAL System Uplift</i>	16
<i>RAL Components Uplift</i>	16

Upgrades

<i>Components</i>	17
<i>Victorian Upgrade</i>	18
<i>Goal Posts</i>	19
<i>Integrated RGB Lighting</i>	20
<i>LED Integrated Spotlights</i>	21
<i>Infrared Outdoor Heaters</i>	22
<i>Shading</i>	23

The Glass Room

<i>Sliding Glass Doors</i>	24
<i>Single Glazed Fixed Side & Front Panels/Frames</i>	26-27

Export Costs

<i>Export Costs</i>	28
---------------------	-----------

The content is the most current at the time of printing however Milwood Group have the right to change any specification at all times without prior notice. This is our policy of continual improvement.





The *Contemporary* Alfresco Glass Roof

DISCOUNT APPLIES

***WARNING NOTES**

Please ensure that wind and snow loading tables are viewed in accordance with the location of the proposed installation.



LENGTH (metres)	PROJECTION (metres)									
	1	2	2.5	3	3.5	4	4.5	5	5.5	6
1	£2,371	£2,728	£2,906	£3,084	£3,360	£3,538	£3,717	£3,895	£4,073	£4,251
2	£2,974	£3,471	£3,720	£3,968	£4,354	£4,603	£4,852	£5,100	£5,349	£5,598
3	£3,576	£4,214	£4,534	£4,853	£5,358	£5,677	£5,996	£6,316	£6,635	£6,954
4	£4,178	£4,958	£5,347	£5,737	£6,352	£6,742	£7,132	£7,521	£7,911	£8,301
5	£4,991	£6,018	£6,532	£7,046	£7,883	£8,396	£8,910	£9,424	£9,937	£10,451
6	£5,593	£6,762	£7,346	£7,930	£8,877	£9,461	£10,045	£10,629	£11,214	£11,798
7	£6,452	£7,762	£8,416	£9,071	£10,137	£10,792	£11,447	£12,101	£12,756	£13,410
8	£7,055	£8,505	£9,230	£9,955	£11,132	£11,857	£12,582	£13,307	£14,032	£14,757
9	£7,867	£9,565	£10,415	£11,264	£12,662	£13,511	£14,360	£15,209	£16,059	£16,908
10	£8,470	£10,309	£11,228	£12,148	£13,656	£14,576	£15,496	£16,415	£17,335	£18,254
11	£9,123	£11,103	£12,093	£13,083	£14,711	£15,701	£16,691	£17,681	£18,671	£19,661
12	£9,791	£11,912	£12,972	£14,033	£15,771	£16,831	£17,892	£18,952	£20,013	£21,073
13	£10,794	£13,163	£14,348	£15,532	£17,492	£18,677	£19,861	£21,046	£22,230	£23,415
14	£11,396	£13,907	£15,162	£16,417	£18,486	£19,741	£20,996	£22,251	£23,506	£24,762
15	£11,999	£14,650	£15,975	£17,301	£19,490	£20,816	£22,141	£23,467	£24,792	£26,118
16	£12,601	£15,393	£16,789	£18,185	£20,484	£21,880	£23,276	£24,672	£26,068	£27,464
17	£13,414	£16,454	£17,974	£19,494	£22,015	£23,535	£25,055	£26,575	£28,095	£29,615
18	£14,082	£17,263	£18,853	£20,444	£23,075	£24,665	£26,256	£27,846	£29,437	£31,027
19	£14,875	£18,197	£19,858	£21,519	£24,269	£25,930	£27,591	£29,252	£30,913	£32,574
20	£15,478	£18,940	£20,672	£22,403	£25,264	£26,995	£28,726	£30,458	£32,189	£33,921
21	£16,341	£20,052	£21,907	£23,763	£26,845	£28,700	£30,556	£32,411	£34,267	£36,122
22	£16,943	£20,795	£22,721	£24,647	£27,839	£29,765	£31,691	£33,617	£35,543	£37,469
23	£17,545	£21,538	£23,535	£25,531	£28,843	£30,839	£32,836	£34,832	£36,828	£38,825
24	£18,213	£22,347	£24,414	£26,481	£29,902	£31,969	£34,036	£36,103	£38,170	£40,237
25	£19,217	£23,599	£25,790	£27,981	£31,624	£33,815	£36,006	£38,197	£40,388	£42,579

Guide for installation times

1 day	2 days	3 days	4 days
-------	--------	--------	--------

TRADE PRICES INCLUDE THE FOLLOWING:

- All aluminium profiles
- 8mm toughened glass roof panels
- End plates and joining plates
- Post feet
- Plastic down pipes and clips
- Fasteners
- Sikaflex
- Silicon
- Packaging and delivery

TRADE PRICES DO NOT INCLUDE THE FOLLOWING:

- VAT
- Concrete or any other aggregate material
- Cover to underside of bolster bars which is an additional cost of £10 per metre

AVAILABLE IN THE FOLLOWING STANDARD COLOURS:

- RAL 7016 Anthracite Grey (*Textured*)

POSTS

150mm x 150mm Alfresco/Sim Free Posts -

Any post over 3m - additional cost of £300 +VAT per post (incl. post trim)

See Page 16 if you require an alternative RAL colour.

The *Simplicity Xtra*

DISCOUNT APPLIES

*WARNING NOTES

Please ensure that wind and snow loading tables are viewed in accordance with the location of the proposed installation.



LENGTH (metres)	PROJECTION (metres)					
	1	2	2.5	3	3.5	4
1	£2,129	£2,361	£2,477	£2,612	£2,693	£2,812
2	£2,554	£2,941	£3,174	£3,405	£3,605	£3,844
3	£2,941	£3,483	£3,715	£4,044	£4,324	£4,643
4	£3,328	£4,103	£4,412	£4,875	£5,198	£5,597
5	£3,870	£4,799	£5,264	£5,746	£6,226	£6,706
6	£4,257	£5,302	£5,805	£6,461	£6,945	£7,506
7	£4,644	£5,883	£6,502	£7,332	£7,896	£8,499
8	£5,109	£6,502	£7,199	£8,048	£8,847	£9,492
9	£5,535	£7,121	£7,895	£8,841	£9,643	£10,407
10	£5,960	£7,741	£8,553	£9,634	£10,556	£11,555
11	£6,425	£8,360	£9,289	£10,427	£11,391	£12,354
12	£6,812	£8,824	£9,908	£11,220	£12,148	£13,231
13	£7,354	£9,676	£10,682	£12,013	£13,177	£14,418
14	£7,741	£10,218	£11,340	£12,884	£14,244	£15,449
15	£8,205	£10,682	£12,037	£13,561	£14,808	£16,171
16	£8,515	£11,224	£12,695	£14,470	£15,682	£17,281
17	£9,056	£12,075	£13,507	£15,185	£16,788	£18,390
18	£9,444	£12,540	£14,165	£15,824	£17,429	£19,034
19	£9,831	£13,236	£14,707	£16,617	£18,380	£20,298
20	£10,256	£13,662	£15,559	£17,410	£19,331	£21,252

TRADE PRICES INCLUDE THE FOLLOWING:

- All aluminium profiles
- 6mm toughened glass roof panel
- End plates and joining plates
- Slotted gutter end plates on glass rooms
- Post feet
- Plastic down pipes and clips
- Fasteners
- Sikaflex
- Packaging and delivery

TRADE PRICES DO NOT INCLUDE THE FOLLOWING:

- VAT
- Concrete or any other aggregate
- Specials

AVAILABLE IN THE FOLLOWING STANDARD COLOURS:

- RAL 7016 Anthracite Grey (*Textured*)
- RAL 9005 Jet Black (*Textured*)

See Page 16 if you require an alternative RAL colour.

Spotlights available - Please refer to page 21.

Guide for installation times

1 day	2 days	3 days	4 days
-------	--------	--------	--------

ALTERNATIVE ROOF OPTIONS (NO DISCOUNT APPLIES)

PROJECTIONS	UP TO 3.2m	UP TO 3.5m	UP TO 4m
Anti Sun Grey	£53.00	£76.00	£99.00
Anti Sun Bronze	£53.00	£76.00	£99.00
Anti Sun Green	£53.00	£76.00	£99.00
Anti Sun Blue	£88.00	N/A	N/A
Self Cleaning Clear	£54.00	£81.00	£81.00

* Additional Price to be added per SQ/MT * Please check availability prior to Ordering

PROJECTIONS	UP TO 3.0m
Satin Glass	£23.00

POSTS

70mm x 70mm Square Posts - Any post over 3m - additional cost of £135 +VAT per post

70mm x 75mm Standard Posts - Any post over 3m - additional cost of £135 +VAT per post

70mm x 100mm Sim Xtra Posts - Any post over 3m - additional cost of £150 +VAT per post

New Simplicity Xtra Upgrades

PREMIUM END PLATES – no fixings on show
This upgrade offers a sleek and rounded contemporary look to the Simplicity Xtra ensuring that fixings remain discreet, contributing to a visually pleasing and sophisticated outdoor space for your customers.

Wall Plate Ends: £19 each | Gutter end Plates: £32 each

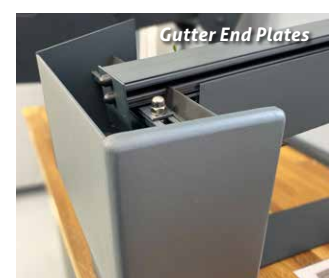

The *Simplicity 6*

DISCOUNT APPLIES

*WARNING NOTES

Please ensure that wind and snow loading tables are viewed in accordance with the location of the proposed installation.



LENGTH (metres)	PROJECTION (metres)					
	1	2	2.5	3	3.2	3.5
1	£1,199	£1,348	£1,422	£1,496	£1,696	£2,033
2	£1,419	£1,691	£1,826	£1,963	£2,351	£2,817
3	£1,746	£2,142	£2,340	£2,537	£3,009	£3,604
4	£1,964	£2,484	£2,745	£3,004	£3,663	£4,389
5	£2,182	£2,827	£3,149	£3,471	£4,319	£5,171
6	£2,509	£3,277	£3,662	£4,046	£4,977	£5,959
7	£2,752	£3,646	£4,091	£4,538	£5,656	£6,772
8	£3,079	£4,096	£4,604	£5,113	£6,419	£7,686
9	£3,297	£4,439	£5,010	£5,580	£6,969	£8,343
10	£3,516	£4,781	£5,414	£6,047	£7,623	£9,127
11	£3,953	£5,342	£6,036	£6,731	£8,497	£10,172
12	£4,196	£5,709	£6,466	£7,223	£9,070	£10,859
13	£4,544	£6,182	£7,001	£7,820	£9,856	£11,799
14	£4,763	£6,524	£7,405	£8,287	£10,510	£12,582
15	£4,981	£6,867	£7,810	£8,753	£11,060	£13,239
16	£5,308	£7,319	£8,322	£9,327	£11,823	£14,152
17	£5,527	£7,661	£8,728	£9,794	£12,478	£14,937
18	£5,879	£8,136	£9,266	£10,394	£13,160	£15,754
19	£6,097	£8,479	£9,670	£10,861	£13,816	£16,538
20	£6,316	£8,821	£10,075	£11,328	£14,470	£17,322
21	£6,752	£9,382	£10,698	£12,013	£15,237	£18,240
22	£6,970	£9,724	£11,102	£12,480	£15,892	£19,022
23	£7,297	£10,176	£11,615	£13,055	£16,655	£19,937
24	£7,540	£10,543	£12,045	£13,547	£17,230	£20,623
25	£7,781	£10,907	£12,472	£14,035	£17,907	£21,434

TRADE PRICES INCLUDE THE FOLLOWING:

- All aluminium profiles
- 6mm toughened glass roof panels
- End plates and joining plates
- Slotted gutter end plates on glass rooms
- Post feet
- Plastic down pipes and clips
- Fasteners
- Sikaflex
- Silicon
- Packaging and delivery

TRADE PRICES DO NOT INCLUDE THE FOLLOWING:

- VAT
- Concrete or any other aggregate material
- Specials

AVAILABLE IN THE FOLLOWING STANDARD COLOURS:

- RAL 9016 Traffic White (*Semi-Gloss*)
- RAL 7016 Anthracite Grey (*Textured*)
- RAL 9005 Jet Black (*Textured*)

See Page 16 if you require an alternative RAL colour.

Guide for installation times

1 day	2 days	3 days	4 days
-------	--------	--------	--------

ALTERNATIVE ROOF OPTIONS (NO DISCOUNT APPLIES)

PROJECTIONS	UP TO 3.2m	UP TO 3.5m	UP TO 4m
Anti Sun Grey	£53.00	£76.00	£99.00
Anti Sun Bronze	£53.00	£76.00	£99.00
Anti Sun Green	£53.00	£76.00	£99.00
Anti Sun Blue	£88.00	N/A	N/A
Self Cleaning Clear	£54.00	£81.00	£81.00

* Additional Price to be added per SQ/MT

* Please check availability prior to Ordering

PROJECTIONS	UP TO 3.0m
Satin Glass	£23.00

POSTS

70mm x 70mm Square Posts -
Any post over 3m -
additional cost of £135 +VAT per post

70mm x 75mm Standard Posts -
Any post over 3m -
additional cost of £135 +VAT per post

70mm x 100mm Sim Xtra Posts -
Any post over 3m -
additional cost of £150 +VAT per post

The *Simplicity 16*

DISCOUNT APPLIES

***WARNING NOTES**

Please ensure that wind and snow loading tables are viewed in accordance with the location of the proposed installation.



LENGTH (metres)	PROJECTION (metres)					
	1	2	2.5	3	3.5	4
1	£1,175	£1,259	£1,301	£1,343	£1,469	£1,610
2	£1,315	£1,464	£1,539	£1,614	£1,856	£2,099
3	£1,541	£1,755	£1,863	£1,970	£2,245	£2,519
4	£1,681	£1,961	£2,101	£2,240	£2,632	£3,030
5	£1,821	£2,166	£2,338	£2,511	£3,019	£3,534
6	£2,047	£2,457	£2,662	£2,867	£3,408	£3,948
7	£2,207	£2,682	£2,920	£3,157	£3,815	£4,474
8	£2,433	£2,973	£3,243	£3,514	£4,288	£5,067
9	£2,573	£3,178	£3,481	£3,784	£4,591	£5,400
10	£2,713	£3,384	£3,719	£4,054	£4,978	£5,904
11	£3,026	£3,762	£4,130	£4,498	£5,538	£6,578
12	£3,186	£3,987	£4,387	£4,788	£5,861	£6,934
13	£3,429	£4,295	£4,728	£5,161	£6,351	£7,556
14	£3,569	£4,500	£4,966	£5,432	£6,738	£8,045
15	£3,709	£4,706	£5,204	£5,702	£7,041	£8,378
16	£3,935	£4,997	£5,528	£6,059	£7,514	£8,971
17	£4,075	£5,202	£5,765	£6,329	£7,901	£9,475
18	£4,321	£5,513	£6,109	£6,705	£8,310	£9,919
19	£4,461	£5,718	£6,347	£6,976	£8,697	£10,419
20	£4,601	£5,923	£6,585	£7,246	£9,084	£10,922
21	£4,914	£6,301	£6,995	£7,689	£9,560	£11,430
22	£5,054	£6,507	£7,233	£7,960	£9,947	£11,934
23	£5,280	£6,798	£7,557	£8,316	£10,420	£12,524
24	£5,439	£7,023	£7,814	£8,606	£10,743	£12,879
25	£5,597	£7,245	£8,070	£8,894	£11,147	£13,408

TRADE PRICES INCLUDE THE FOLLOWING:

- All aluminium profiles
- 16mm multi-wall polycarbonate roof sheets
- End plates and joining plates
- Slotted gutter end plates on glass rooms
- Post feet
- Plastic down pipes and clips
- Fasteners
- Sikaflex
- Silicon
- Packaging and delivery

Plus a choice of:

- Clear poly
- Bronze poly
- Opal poly

TRADE PRICES DO NOT INCLUDE THE FOLLOWING:

- VAT
- Concrete or any other aggregate material
- Specials

AVAILABLE IN THE FOLLOWING STANDARD COLOURS:

- RAL 9016 Traffic White (*Semi-Gloss*)
- RAL 7016 Anthracite Grey (*Textured*)
- RAL 9005 Jet Black (*Textured*)

See Page 16 if you require an alternative RAL colour.

Guide for installation times

1 day	2 days	3 days
-------	--------	--------

ALTERNATIVE ROOF OPTIONS (NO DISCOUNT APPLIES)

	PROJECTIONS
	Up to 6m
16mm Heatshield	£2.80

* Additional Price to be added per SQ/MT

* Please check availability prior to Ordering

POSTS

70mm x 70mm Square Posts - Any post over 3m - additional cost of £135 +VAT per post

70mm x 75mm Standard Posts - Any post over 3m - additional cost of £135 +VAT per post

70mm x 100mm Sim Xtra Posts - Any post over 3m - additional cost of £150 +VAT per post

The *Simplicity 35*

DISCOUNT APPLIES

***WARNING NOTES**

Please ensure that wind and snow loading tables are viewed in accordance with the location of the proposed installation.



LENGTH (metres)	PROJECTION (metres)									
	1	2	2.5	3	3.5	4**	4.5	5	5.5	6
1	£1,292	£1,418	£1,507	£1,595	£1,696	£1,719	£2,052	£2,075	£2,141	£2,164
2	£1,426	£1,713	£1,843	£1,973	£2,133	£2,180	£2,638	£2,685	£3,131	£3,178
3	£1,692	£2,008	£2,180	£2,351	£2,624	£2,694	£3,483	£3,554	£4,350	£4,420
4	£2,019	£2,418	£2,630	£2,843	£3,228	£3,322	£4,184	£4,278	£5,572	£5,666
5	£2,231	£2,766	£3,034	£3,301	£3,719	£3,836	£5,029	£5,147	£6,562	£6,680
6	£2,443	£3,088	£3,404	£3,719	£4,209	£4,350	£5,616	£5,757	£7,553	£7,694
7	£2,923	£3,677	£4,041	£4,404	£4,967	£5,132	£6,584	£6,748	£9,042	£9,207
8	£3,250	£4,113	£4,525	£4,937	£5,572	£5,760	£7,429	£7,617	£10,033	£10,221
9	£3,462	£4,435	£4,895	£5,355	£6,063	£6,274	£8,015	£8,227	£11,023	£11,234
10	£3,674	£4,757	£5,265	£5,773	£6,553	£6,788	£8,975	£9,210	£12,245	£12,480
11	£4,270	£5,381	£5,937	£6,493	£7,346	£7,605	£9,750	£10,008	£13,424	£13,682
12	£4,780	£5,988	£6,592	£7,196	£8,121	£8,404	£10,879	£11,161	£14,698	£14,981
13	£5,006	£6,310	£6,962	£7,614	£8,612	£8,918	£11,580	£11,886	£15,921	£16,227
14	£5,232	£6,632	£7,332	£8,032	£9,103	£9,432	£12,167	£12,496	£16,911	£17,240
15	£5,572	£7,068	£7,816	£8,564	£9,707	£10,060	£13,012	£13,364	£17,901	£18,254
16	£5,798	£7,390	£8,186	£8,982	£10,198	£10,574	£13,713	£14,089	£19,124	£19,500
17	£6,023	£7,712	£8,556	£9,400	£10,688	£11,088	£14,558	£14,957	£20,114	£20,514
18	£6,631	£8,415	£9,307	£10,199	£11,561	£11,984	£15,411	£15,835	£21,371	£21,795
19	£6,856	£8,737	£9,677	£10,617	£12,051	£12,498	£16,371	£16,817	£22,594	£23,041
20	£7,082	£9,059	£10,047	£11,035	£12,542	£13,012	£16,957	£17,428	£23,584	£24,054
21	£7,496	£9,569	£10,605	£11,641	£13,220	£13,714	£17,732	£18,226	£24,762	£25,256
22	£7,836	£10,005	£11,089	£12,174	£13,825	£14,342	£18,691	£19,209	£25,985	£26,502
23	£8,062	£10,327	£11,459	£12,592	£14,316	£14,856	£19,278	£19,819	£26,975	£27,516
24	£8,572	£10,933	£12,114	£13,294	£15,091	£15,655	£20,408	£20,972	£28,250	£28,814
25	£8,913	£11,370	£12,598	£13,827	£15,696	£16,284	£21,109	£21,696	£29,473	£30,060

Guide for installation times

1 day	2 days	3 days	4 days
-------	--------	--------	--------

**If the difference in the back and front height exceeds 1080mm on a 4m projection you will need to price into the next projection bracket of 4.5m projection. This is due to the bar exceeding 4m.

TRADE PRICES INCLUDE THE FOLLOWING:

- All aluminium profiles
- 35mm multi-wall polycarbonate roof sheets
- End plates & joining plates
- Post feet
- Plastic down pipes & clips
- Fasteners
- Sikalex and Silicon
- Packaging and delivery

Plus a choice of:

- Clear poly
- Bronze poly
- Opal poly

TRADE PRICES DO NOT INCLUDE THE FOLLOWING:

- VAT
- Concrete or any other aggregate material
- Specials

AVAILABLE IN THE FOLLOWING STANDARD COLOURS:

- RAL 9016 Traffic White (*Semi Gloss*)
- RAL 7016 Anthracite Grey (*Textured*)

See Page 16 if you require an alternative RAL colour.

ALTERNATIVE ROOF OPTIONS (NO DISCOUNT APPLIES)

	PROJECTIONS
35mm Heatshield	Up to 6m
Grey/Opal	£3.20
Bronze/Opal	£5.00
* Additional Price to be added per SQ/MT	
* Please check availability prior to Ordering	

POSTS

80mm x 80mm Sim 35 Posts - Any post over 3m - additional cost of £135 +VAT per post

The *Simplicity Free (Mono)*

DISCOUNT APPLIES

LENGTH (metres)	PROJECTION (metres)				
	2	2.5	3	3.5	4
2	£4,458	£4,769	£5,080	£5,418	£5,757
3	£5,175	£5,644	£6,067	£6,518	£6,998
4	£5,898	£6,462	£7,055	£7,619	£8,212
5	£7,619	£8,324	£9,030	£9,736	£10,441
6	£8,319	£9,160	£10,046	£10,836	£11,682
7	£9,030	£10,018	£10,977	£11,965	£12,981
8	£9,764	£10,864	£11,965	£13,094	£14,166
9	£11,457	£12,699	£13,940	£15,239	£16,480
10	£12,191	£13,545	£14,916	£16,282	£17,665
11	£12,924	£14,391	£15,916	£17,496	£18,906
12	£13,658	£15,239	£16,931	£18,512	£20,318

Guide for installation times

1 day	2 days	3 days
-------	--------	--------

ALTERNATIVE ROOF OPTIONS (NO DISCOUNT APPLIES)

PROJECTIONS	UP TO 3.2m	UP TO 3.5m	UP TO 4m
Anti Sun Grey	£53.00	£76.00	£99.00
Anti Sun Bronze	£53.00	£76.00	£99.00
Anti Sun Green	£53.00	£76.00	£99.00
Anti Sun Blue	£88.00	N/A	N/A

* Additional Price to be added per SQ/MT

* Please check availability prior to Ordering

PROJECTIONS	UP TO 3.0m
Satin Glass	£23.00

Note: Any sizes over 16sqm will be overweight on the standard Milwood vehicle. Therefore, outsourced transport will be required which is POA. Please contact the Sales Team.

*WARNING NOTES

Please ensure that wind and snow loading tables are viewed in accordance with the location of the proposed installation.



TRADE PRICES INCLUDE THE FOLLOWING:

- All aluminium profiles
- 6mm toughened glass roof panels
- End plates and joining plates (if required)
- Post bolt down brackets
- Plastic down pipes and outlets
- Fasteners
- Sikaflex
- Silicon
- Packaging and delivery

TRADE PRICES DO NOT INCLUDE THE FOLLOWING:

- VAT
- Concrete or any other aggregates
- Specials

AVAILABLE IN THE FOLLOWING STANDARD COLOURS:

- RAL 7016 Anthracite Grey (*Textured*)
- RAL 9005 Jet Black (*Textured*)

See Page 16 if you require an alternative RAL colour.



The *Simplicity Free* (Apex)

DISCOUNT APPLIES

LENGTH (metres)	PROJECTION (metres)			
	3	4	5	6
3	£7,300	£8,300	£9,300	£11,000
4	£8,550	£9,800	£10,550	£12,050

Diagrams opposite showing Sim Free Apex layouts of 6m length & 4m projection and 4m length & 6m projection.

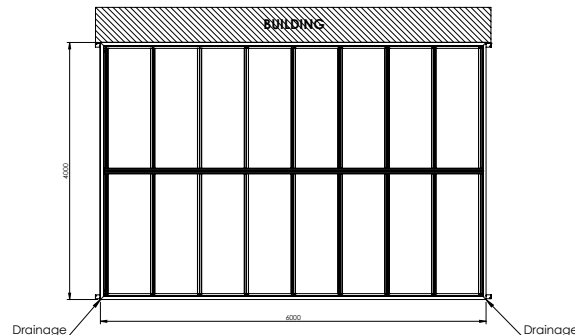

ALTERNATIVE ROOF OPTIONS (NO DISCOUNT APPLIES)

PROJECTIONS	UP TO 3.2m	UP TO 3.5m	UP TO 4m
Anti Sun Grey	£53.00	£76.00	£99.00
Anti Sun Bronze	£53.00	£76.00	£99.00
Anti Sun Green	£53.00	£76.00	£99.00
Anti Sun Blue	£88.00	N/A	N/A

* Additional Price to be added per SQ/MT
* Please check availability prior to Ordering

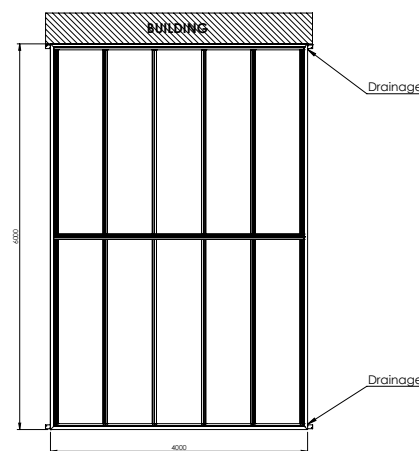

PROJECTIONS	UP TO 3.0m
Satin Glass	£23.00

Note: Any sizes over 16sqm will be overweight on the standard Milwood vehicle. Therefore, outsourced transport will be required which is POA. Please contact the Sales Team.



POSTS

150mm x 150mm Sim Free Posts - Any post over 3m - additional cost of £300 +VAT per post

Privacy Screens

NO DISCOUNT APPLIES

BACK HEIGHT (Metres)	PROJECTION (metres)						
	1	1.5	2	2.5	3	3.5	4
2.0	£314	£410	£507	£605	£702	£800	£895
2.2	£343	£449	£554	£659	£766	£872	£979
2.4	£372	£488	£601	£718	£831	£946	£1,061
2.6	£402	£527	£649	£772	£897	£1,020	£1,143
2.8	£431	£562	£694	£829	£961	£1,094	£1,229
3.0	£460	£603	£745	£883	£1,026	£1,166	£1,310
3.2	£489	£640	£790	£940	£1,092	£1,240	£1,392
3.4	£521	£679	£839	£996	£1,156	£1,316	£1,474
3.6	£548	£720	£885	£1,053	£1,221	£1,390	£1,560
3.8	£577	£757	£932	£1,112	£1,287	£1,463	£1,642
4.0	£606	£794	£981	£1,166	£1,353	£1,539	£1,724



240mm Interlocking Jumbo Boards with a Post Adapter Framework all the way round.

Post packers to be used and the front and back to avoid notching.

Provided to the full size up to the back height to be cut down to suit on site.



The *A-Fence*

NO DISCOUNT APPLIES

Interlocking Board

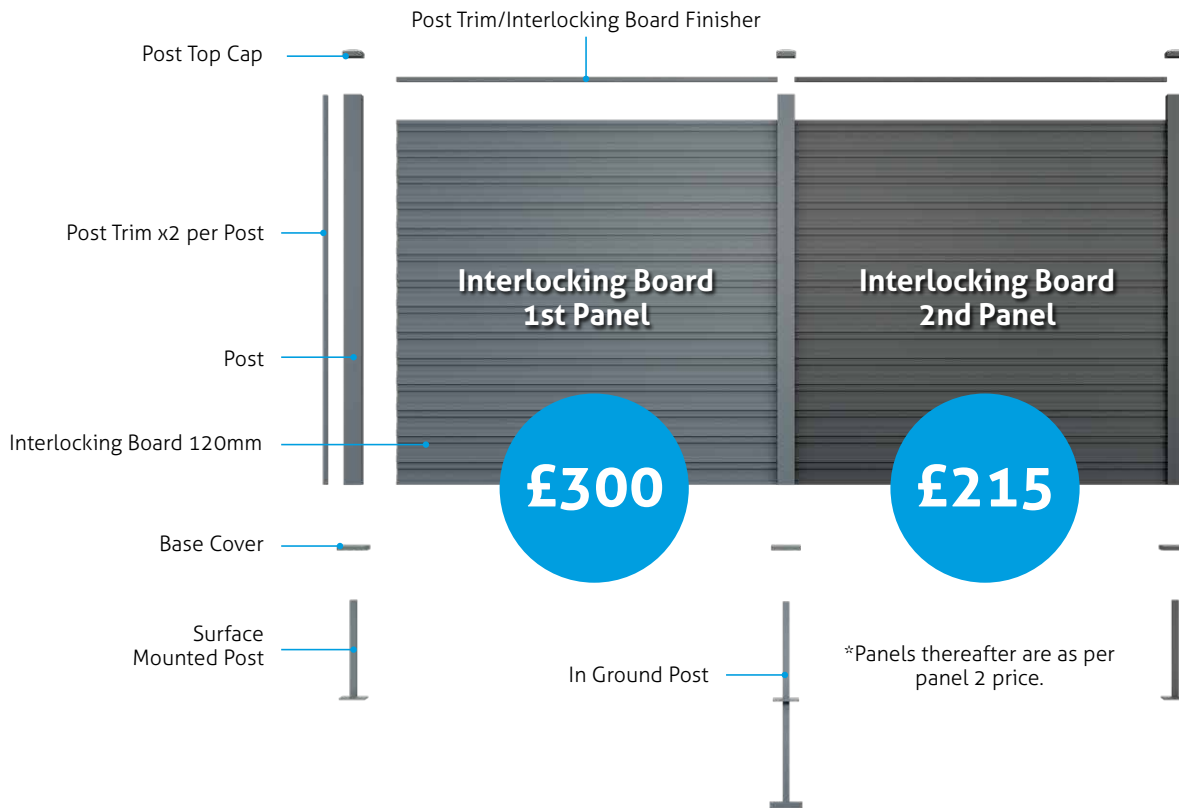

120mm Interlocking Boards

INTERLOCKING BOARD SYSTEM		
Size	1st Panel	2nd Panel
0.96M High x 1.8M Wide	£185.00	£130.00
1.8M High x 1.8M Wide	£300.00	£215.00

TRADE PRICES INCLUDE THE FOLLOWING:

- Board Cut to the Width
- Posts
- Post Trims
- Posts Top Capping
- Spacers (if required)
- Powder Coated to Textured Finish (see colours available)
- In Ground Posts or Surfaced Mounted Posts
- Post Base Plate Cover

TRADE PRICES DO NOT INCLUDE THE FOLLOWING:

- VAT
- Concrete or any other aggregates

AVAILABLE IN THE FOLLOWING STANDARD COLOURS:

- RAL 7016 Anthracite Grey (*Textured*)
- RAL 9005 Jet Black (*Textured*)



Slat combinations

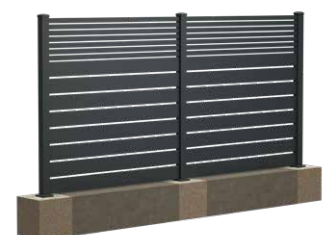

NO DISCOUNT APPLIES

Slatted Board

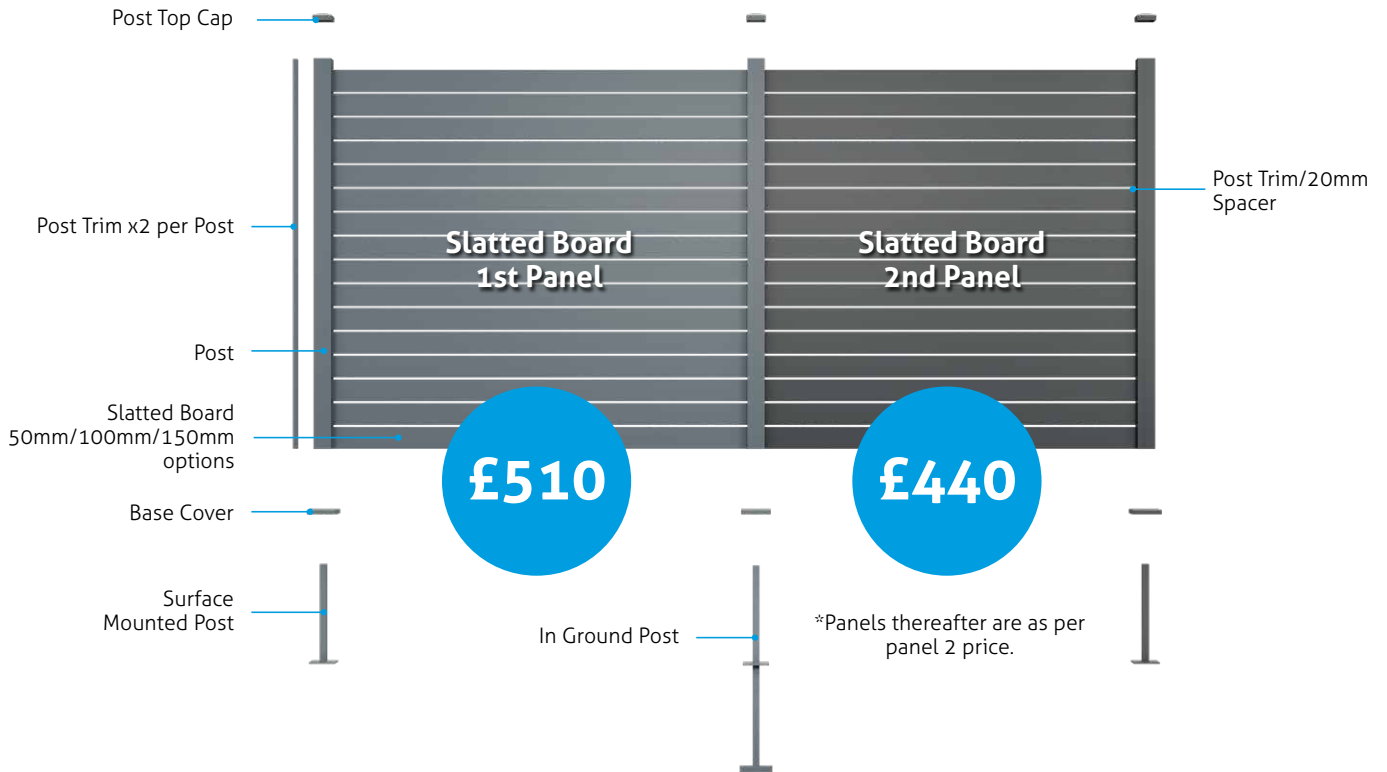

SLATTED BOARD SYSTEM						
Size	50mm 1st Panel	50mm 2nd Panel	100mm 1st Panel	100mm 2nd Panel	150mm 1st Panel	150mm 2nd Panel
0.96M High x 1.8M Wide	£345.00	£280.00	£310.00	£245.00	£290.00	£225.00
1.8M High x 1.8M Wide	£510.00	£440.00	£465.00	£395.00	£420.00	£350.00

POST CROSS SECTION

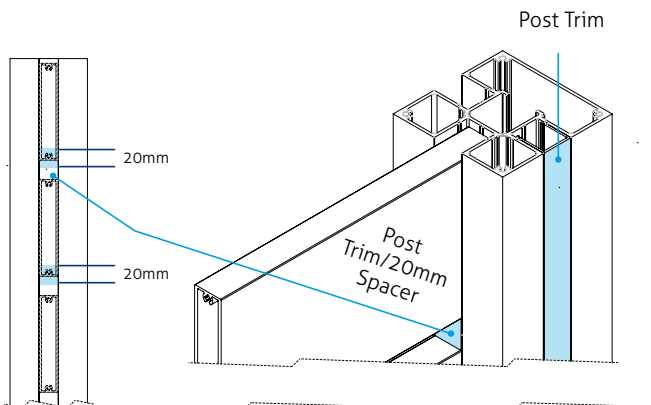

POST ACCESSORIES

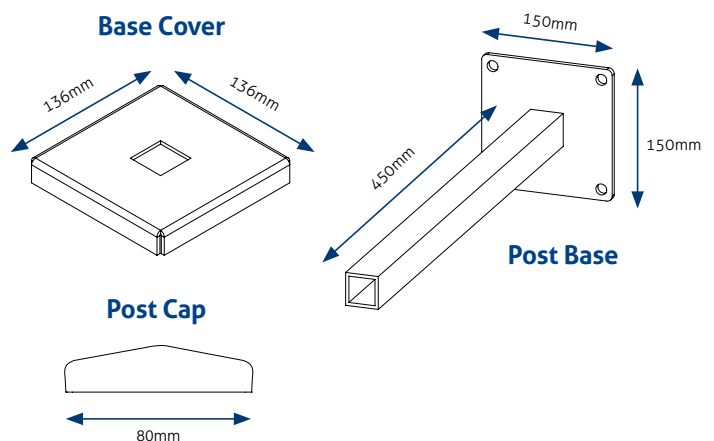

NO DISCOUNT APPLIES

FENCE EXPLODED VIEW

INDIVIDUAL COMPONENTS		
Components	Price	Per 1.8m Length
Post	£35.00	1.8M
Post Trim	£3.50	1.8M
Interlocking Board 120mm	£11.50	1.8M
Interlocking Jumbo Board 240mm	£45.00	1.8M
Post Trim/Interlocking Board Finisher	£3.50	1.8M
Slatted 50mm Board	£12.00	1.8M
Slatted 100mm Board	£22.00	1.8M
Slatted 150mm Board	£30.00	1.8M
Post Top Cap	£5.00	EACH
Base Cover	£5.00	EACH
Surface Mounted Post	£27.00	EACH
In Ground Post	£35.00	EACH
Angle Bracket	£1.50	EACH
Post Trim/20mm Spacer	£0.15	EACH
Gate Profile	£16.50	EACH
Concrete Post Adapter	£15.75	1.8M

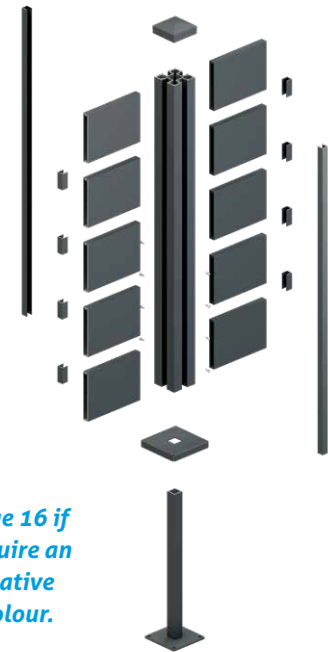

See Page 16 if you require an alternative RAL colour.

Gate



1. Choose your size 1.8 x 0.9m or 0.9 x 0.9m
2. Choose your boards from the component list
3. Add the Gate Profile and End Caps

Example price does not include delivery - POA

Pricing Example

PRODUCT	COST
15 x 120 interlocking boards 1.8m (to be cut down to suit on site to required width)	£172.50
2 x posts 1.8m	£70.00
3 x post trim 1.8m	£10.50
2 x Gate Profile 1.8m	£33.00
2 x Gate Profile End Plates	£7.00
2 x post feet	£54.00
2 x base covers	£10.00
TOTAL	£357.00*

*Plus VAT

A-Fence Concrete Post Adapter



Use when existing concrete posts are to remain in place.

£15.75 per 1.8 metre length

Then choose from the table above which slat option you need.

Pricing Example

PRODUCT	COST
2 x 1.8m Concrete Post Adapter	£31.50*
5 x 150mm boards, 1.8m wide	£150.00
1 x 100mm boards, 1.8m wide	£22.00
1 x 50mm boards, 1.8m wide	£12.00
4 x Spacers	£2.40
TOTAL	£217.90**

*includes end cap **Plus VAT

The *A-Fence* Slat/Board Types

5
DIFFERENT
PROFILE
SIZES

50mm Slats



100mm Slats



**FULLY
MODULAR
DESIGN**

150mm Slats



120mm Interlocking Boards



SLAT PROFILES

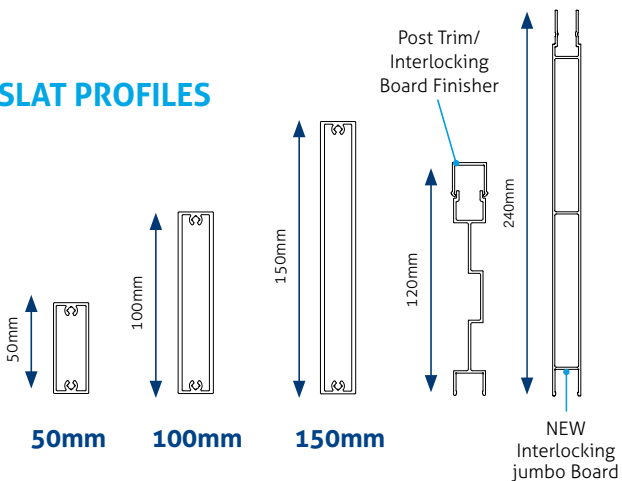

240mm Interlocking Jumbo Boards



Non-Standard *RAL System Uplift*

NO DISCOUNT APPLIES

WIDTH (metres)	PROJECTION (metres)											
	1.0	1.5	2.0	2.5	3.0	3.5	4.0	4.5	5.0	5.5	6.0	
1	£900	£900	£900	£900	£900	£900	£900	£900	£900	£900	£900	£900
2	£900	£900	£900	£900	£900	£900	£900	£900	£900	£900	£1,200	£1,200
3	£900	£900	£900	£900	£900	£1,200	£1,200	£1,500	£1,500	£1,500	£1,500	£1,500
4	£900	£900	£900	£900	£1,200	£1,500	£1,500	£1,500	£1,500	£2,000	£2,000	£2,000
5	£900	£900	£900	£1,500	£1,500	£1,500	£1,500	£2,000	£2,000	£2,000	£2,000	£2,000
6	£900	£900	£1,200	£1,500	£1,500	£2,000	£2,000	£2,000	£2,000	£2,500	£2,500	£2,500
7	£900	£1,200	£1,500	£1,500	£2,000	£2,000	£2,000	£2,500	£2,500	£2,500	£2,500	£2,750
8	£900	£1,200	£1,500	£1,500	£2,000	£2,000	£2,500	£2,500	£2,500	£2,750	£2,750	£2,750
9	£900	£1,500	£1,500	£2,000	£2,000	£2,500	£2,500	£2,750	£2,750	£2,750	£2,750	£3,000
10	£900	£1,500	£1,500	£2,000	£2,000	£2,500	£2,500	£2,750	£2,750	£3,000	£3,000	£3,000
11	£1,200	£1,500	£2,000	£2,000	£2,500	£2,500	£2,750	£2,750	£3,000	£3,500	£3,500	£3,500
12	£1,200	£1,500	£2,000	£2,000	£2,500	£2,750	£2,750	£3,000	£3,000	£3,500	£3,500	£3,500
13	£1,500	£1,500	£2,000	£2,500	£2,500	£2,750	£3,000	£3,000	£3,500	£3,500	£3,500	£3,500
14	£1,500	£2,000	£2,000	£2,500	£2,750	£2,750	£3,000	£3,500	£3,500	£3,500	£3,500	£3,500
15	£1,500	£2,000	£2,000	£2,500	£2,750	£3,000	£3,000	£3,500	£3,500	£3,500	£3,500	£3,500
16	£1,500	£2,000	£2,500	£2,500	£2,750	£3,000	£3,500	£3,500	£3,500	£3,500	£3,500	£3,500
17	£1,500	£2,000	£2,500	£2,750	£3,000	£3,000	£3,500	£3,500	£3,500	£4,000	£4,000	£4,000
18	£1,500	£2,000	£2,500	£2,750	£3,000	£3,500	£3,500	£3,500	£3,500	£4,000	£4,000	£4,000
19	£1,500	£2,000	£2,500	£2,750	£3,000	£3,500	£3,500	£3,500	£4,000	£4,000	£4,000	£4,000
20	£1,500	£2,000	£2,500	£2,750	£3,000	£3,500	£3,500	£3,500	£4,000	£4,000	£4,000	£4,000

THE FOLLOWING PRICES INCLUDE:

- Applicable to all Systems

THE FOLLOWING PRICES DO NOT INCLUDE:

- VAT

Non-Standard *Additional Components Uplift*

ADDITIONAL COMPONENTS	SELLING PRICE
Sliding Doors	POA
Fixed Panels	POA
Cheese Frames	POA
Goal Posts	POA

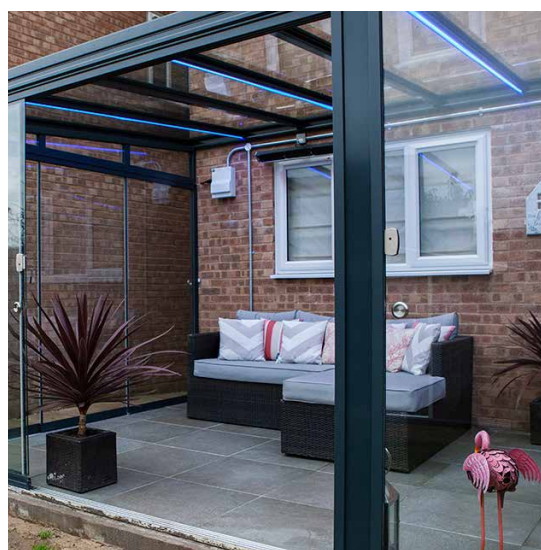

Components

NO DISCOUNT APPLIES

Minimum order value - £150.00 +VAT

SIMPLICITY 6	SELLING PRICE PER M
Main Glazing Bar	£45.00
End Glazing Bar	£45.00
Glazing Bar End Plates	£9.00 each
F Section	£15.00

SIMPLICITY 16	SELLING PRICE PER M
Main Glazing Bar	£45.00
End Glazing Bar	£45.00
Glazing Bar End Plates	£9.00 each
F Section Top	£15.00
F Section Bottom (Holes)	£15.00

COMMON PARTS SIMPLICITY 6 & 16	SELLING PRICE PER M
Wall Plate	£75.00
Wall Plate End Plates	£12.00 each
Gutter	£85.00
Gutter End Plates	£12.00 each
Gutter End Plate Slotted	£15.00 each
Post 75mm x 70mm †	£45.00
Post 70mm x 70mm †	£45.00
Post 70mm x 100mm †	£50.00
Post 70mm x 100mm End Plate	£12.00
Gutter & Wall Plate Trim	£20.00
Gutter Support Channel	£40.00
In Ground Post Bracket	£12.00 each
Bolt to Ground Cleat	£15.00 each

SIMPLICITY 35	SELLING PRICE PER M
Main Bar	£60.00
End Bar	£60.00
Bar End Plates	£7.50 each
Wall Plate	£70.00
Gutter	£90.00
Pitch Strip	£20.00
Post 80mm x 80mm	£45.00
F Section	£15.00

GUTTER SUPPORT KIT SIM 6 & 16 ONLY	SELLING PRICE PER M
70mm x 100mm Support Beam (max 4m)	£200.00 per 4m length
Support Beam End Plates	£10.00 each

SIMPLICITY XTRA	SELLING PRICE PER M
Wall Plate	£75.00
Wall Plate End Plates	£12.00
Wall Plate Pitch Adjuster	£12.00
Premium Wall Plate End Plate	£30.00
Bolster Bar	£55.00
Top Cap	£15.00
End Top Cap	£15.00
Bar End Plates	£5.00 each
Plastic Glazing Insert	£8.00
Eaves Beam	£95.00
Eaves Beam Pitch Adjuster	£12.00
Gutter End Plate Slotted	£16.00 each
Premium Gutter End Plate	£50.00 each
Gutter	£60.00
Gutter End Plates	£12.00 each
Square Cover Cap	£10.00
Post 75mm x 70mm*†	£45.00
Post 70mm x 70mm* †	£45.00
Post 70mm x 100mm* †	£50.00
Bolt to Ground Cleat	£15.00 each
In Ground Post Bracket	£12.00 each

CONTEMPORARY ALFRESCO	SELLING PRICE PER M
Wall Plate Wing	£35.00
Wall Plate	£90.00
Wall Plate End Plates	£15.00 each
Main Glazing Bar	£30.00
End Glazing Bar	£30.00
Bar End Plates	£8.00 each
Bolster Bar Eco (4m max)	£75.00
Standard Bolster Bar	£95.00
Glass Connector	£15.00
Flat Post***	£85.00
Flat Post Trim	£15.00
Post Brackets	£15.00 each
Eaves Beam	£125.00
Eaves Beam Pitch Adjuster	£30.00
Gutter	£65.00
Gutter End Plates	£15.00 each
Square Cover Cap	£10.00

- **The Components prices do not include VAT**
- **Delivery Cost TBC**
- **Orders for metres are to be rounded up to the nearest metre**
- **Polycarbonate POA**
- **Glass POA**

*Sim Xtra - extruded in 4m and 6m so charges apply up to the measurements. e.g. 2.4m length required – charged at 4m length

†Square Posts 70mm x 70mm and Standard Posts 75mm x 70mm come in 3m and 6m lengths so charges apply up to the measurements.

***Alfresco Contemporary/Sim Free Posts 150mm x 150mm - extruded in 3m and 6m so charges apply up to these measurements.

Victorian Upgrade

DISCOUNT APPLIES

The Victorian Upgrade transforms our carports and canopies into ornate and beautiful shade and shelter structures which will enhance the exterior of any building.

The Victorian upgrade is easy to install and can be coloured to any of our standard RAL colours to match aesthetics.



Simplicity 35

The Simplicity 35 Victorian Upgrade includes a column base and column sleeve as shown to the right.

Column Base:
£275 + VAT (each)



Column Collar:
£65 + VAT (each)

**Gallows Bracket
(300mm x 300mm):**
£50 + VAT (each)

Simplicity 16 & 6

The Simplicity 16 and the Simplicity 6 Victorian Upgrade includes a tall column base and a gallows bracket.

Tall Column Base:
£280 + VAT (each)



Brackets

CODE MW/CAST/002

- 90° Angle Gallows Bracket
 - 300mm x 300mm
 - Cast Aluminium
- £50 + VAT**

Please see accessories page overleaf for alternative gallows bracket sizes.

All prices include the upgrades being supplied as either white semi gloss, black textured and anthracite grey textured.



Aluminium *Goal Post*

NO DISCOUNT APPLIES

All aluminium 200mm x 120mm profile to use as a goal post structure which can facilitate a freestanding canopy. Designed to be used with the Alfresco, Simplicity 6, 16, 35 and Xtra systems. Pricing must take into consideration that the lengths are available in 4m and 6m.

TRADE PRICES INCLUDE THE FOLLOWING:

- Clip in cover trim
- Beam end plates and fixings
- Delivery when ordered with one of our structures

TRADE PRICES DO NOT INCLUDE THE FOLLOWING:

- VAT
- Concrete or other aggregates
- Delivery if ordered separately from one of our structures. In this instance delivery is POA

AVAILABLE IN FOLLOWING STANDARD COLOURS:

- RAL 9016 Traffic White (*Semi Gloss*)
- RAL 7016 Anthracite Grey (*Textured*)
- RAL 9005 Jet Black (*Textured*)

See Page 16 if you require an alternative RAL colour.

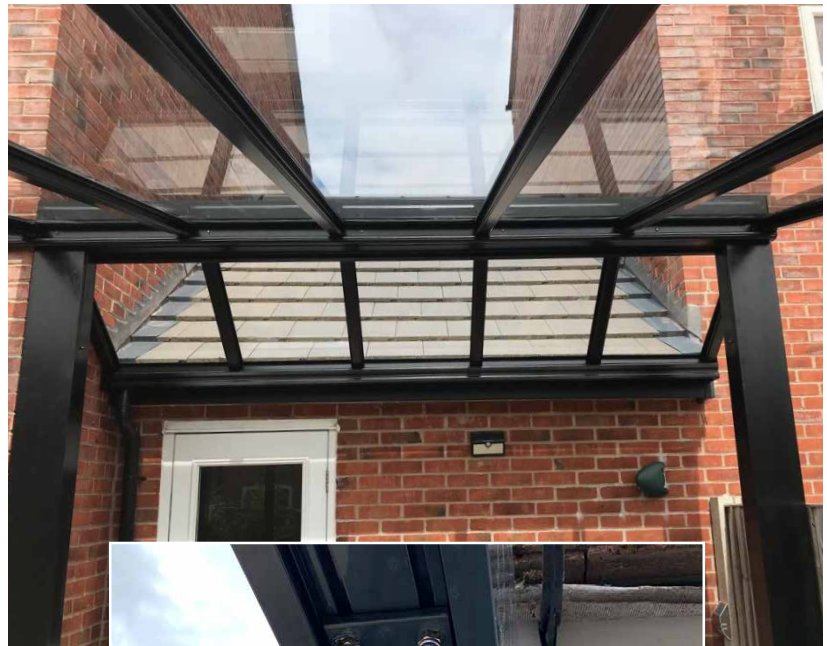

AVAILABLE LENGTHS	PRICE
4m Length*	£280 each
6m Length*	£420 each
Goal Post Brackets	£14 each
Ground Brackets	£12 each

* These are cut down to suit the CAD drawing but allow these full lengths for pricing

• **Bracket positions**

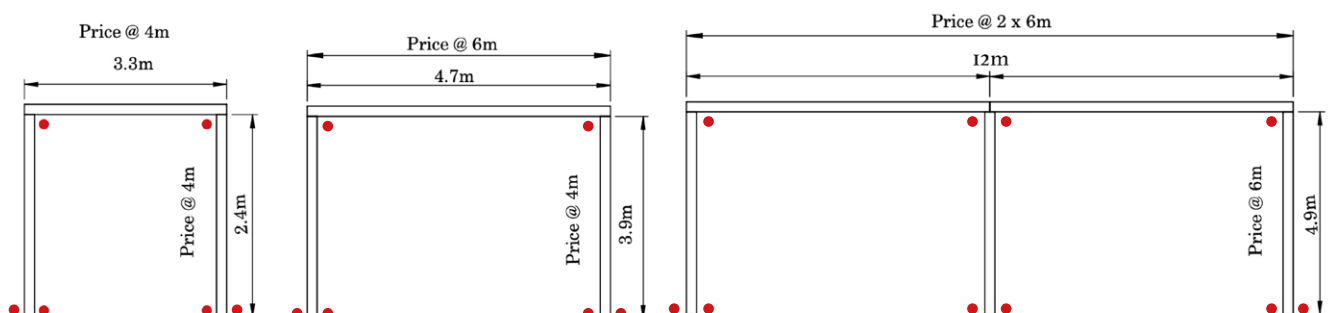

Integrated RGB Lighting Upgrade

NO DISCOUNT APPLIES

APPLICABLE TO SIM 6, 16, 35 & ALFRESCO RANGES ONLY

The LED strip is Red, Green, Blue and Warm White and every colour in between. The Power Consumption is 18W per metre.

NOTE: 1 x receiver is required per driver.

PRODUCT	PRICE
4 Channel Remote Control	£21.00
4 Channel Wall Panel	£28.00
Standard Receiver	£27.00
SMART Receiver	£40.00
1.5m Length of IP65 rated RGBWW Strip	£34.00
3.5m Length of IP65 rated RGBWW Strip	£70.00
6m Length of IP65 rated RGBWW Strip	£110.00

PRODUCT	DIMENSIONS	PRICE
100W Driver*	L180mm, W63mm, H31mm	£56.00
150W Driver*	L180mm, W63mm, H31mm	£63.00
200W Driver*	L195mm, W68mm, H32mm	£73.00
Gewiss Lighting Box	L240mm, W190mm, H90mm	£10.00



Smart Receiver



Standard Receiver



4 Channel Wireless Wall Switch

This lighting is only available in the Main Glazing Bars and not the End Glazing Bars.

***HOW TO CALCULATE THE DRIVERS YOU NEED:**

No. of strips x length of strips x 18w = the total Wattage of the Drivers you need to cover.

All prices quoted are exclusive of VAT.

All these products must be installed by a qualified electrician.

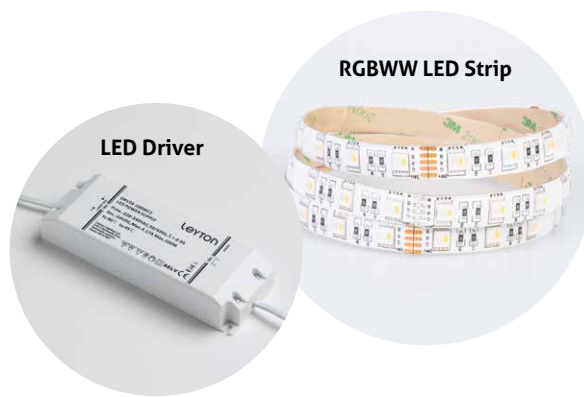

Pricing Examples

PRODUCT	PRICE
4 Channel Remote Control	£21.00
Standard Receiver x2	£54.00
3.5m Strip x4	£280.00
150W Driver x2	£126.00
Gewiss Lighting Box	£10.00
Total +VAT	£491.00

Based on a Simplicity 6 (6m x 3.5m) with lights on every other bar so 4 main bars in total.



4 Channel Remote Control

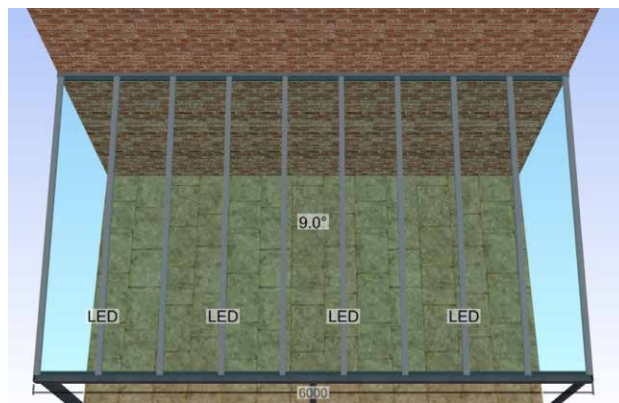

LED Spotlights Upgrade

APPLICABLE TO SIM XTRA & SIM FREE ONLY

PRODUCT	PRICE
Spotlights	£15 per spotlight
Remote, Receiver & Driver Bundle	£145 - 1x Remote, 1x Receiver is always required regardless of the quality of lights
10m Extension Cables	£14 per cable - 1 per spotlight required
15m Extension Cables	£17 per cable - 1 per spotlight required
Electrical Lighting Box	£10 per system - 1 per lighting kit order
Additional 60w Driver	£55 - only required if over 20 spotlights

***Remote, Receiver & Driver Bundle (0-9 spotlights, a 50w driver is required. 10-20 spotlights, a 60w driver is required. If over 20 spotlights an additional 60w driver is required following the previous max number rule).**

Pricing Examples

9 SPOTLIGHT EXAMPLE	PRICE
1x Remote, 1x Receiver, 1x 60w Driver Bundle	£145
9x Spotlights	£135
9 x 10m Extension Cables	£126
1x Electrical Lighting Box	£10
TOTAL +VAT	£416

12 SPOTLIGHT EXAMPLE	PRICE
1x Remote, 1x Receiver, 1x 60w Driver Bundle	£145
12x Spotlights	£180
12 x 10m Extension Cables	£168
1x Electrical Lighting Box	£10
TOTAL +VAT	£503

22 SPOTLIGHT EXAMPLE	PRICE
1x Remote, 1x Receiver, 1x 60w Driver Bundle	£145
22x Spotlights	£330
22 x 10m Extension Cables	£308
1x Electrical Lighting Box	£10
1x 60w Driver	£55
TOTAL +VAT	£848



Please see additional Import/Export charges on page 28.

Infrared Outdoor *Heaters*

NO DISCOUNT APPLIES

Elevate outdoor living projects with our California Heaters, a pinnacle of style and functionality. This page has all the information you need on the California Heating System – including colour options and technical information.

BENEFITS:

- **Versatile Warmth:** Enjoy instant, powerful, and comfortable heat in various settings, from home to commercial areas.
- **Stylish Design:** Enhance outdoor spaces with the sleek and contemporary aesthetics.
- **Silent Operation:** Experience quiet and efficient heating without disrupting the ambient environment.
- **Flexible Placement:** Wall-mount or use a portable stand for adaptable positioning, ensuring optimal comfort.
- **Energy Efficiency:** Achieve environmentally friendly warmth, with mirror aluminium reflectors minimizing heat loss.



ORDER CODE	RATED POWER	SIZE	COLOUR	WEIGHT	PRICE
M-CALIFORNIA-2000R-B	2000W	780 x 130mm	Black	3kg	£295.00
M-CALIFORNIA-2000R-G	2000W	780 x 130mm	Rose Gold	3kg	£295.00
M-CALIFORNIA-2000R-S	2000W	780 x 130mm	Silver	3kg	£295.00

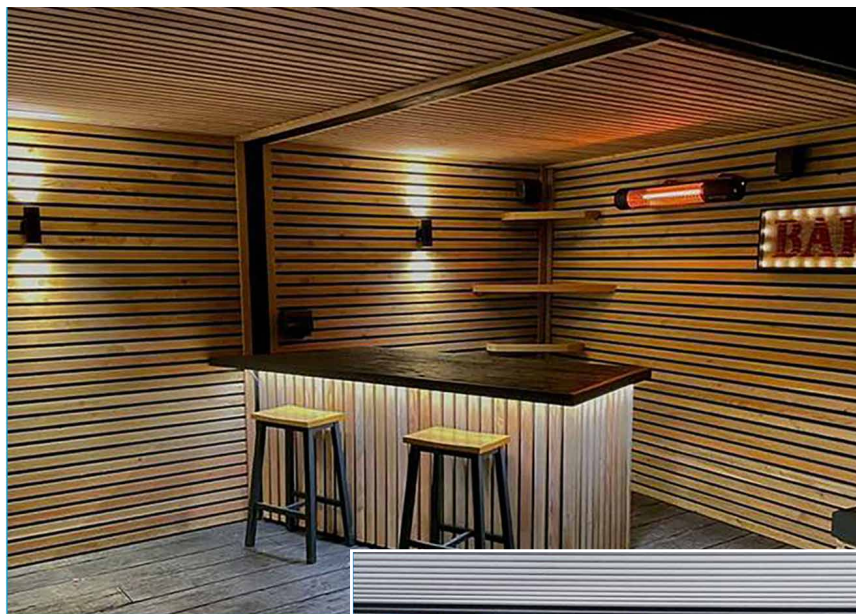

California Heaters with Stand - £335 + VAT

Shading

NO DISCOUNT APPLIES

A choice of Motorised Vertical Roller Blinds and Manually Operated Under Blinds in many different shades and fire-retardant fabrics. Material is a high grade external screen material which is part of the preconstraint range of fabrics; this range is pre-tensioned in both warp and weft directions before coating, this makes the fabric incredibly strong and resistant to stretching.

Motorised Vertical Roller Blinds

Drop	Width								
	800mm	1,000mm	1,200mm	1,400mm	1,600mm	1,800mm	2,000mm	2,200mm	2,400mm
600mm	£1,405	£1,435	£1,465	£1,494	£1,524	£1,608	£1,650	£1,692	£1,733
1000mm	£1,485	£1,513	£1,543	£1,573	£1,602	£1,665	£1,706	£1,748	£1,790
1400mm	£1,562	£1,590	£1,620	£1,650	£1,679	£1,724	£1,766	£1,808	£1,850
1800mm	£1,640	£1,669	£1,698	£1,728	£1,758	£1,909	£1,964	£2,018	£2,072
2200mm	£1,666	£1,694	£1,724	£1,754	£1,783	£1,926	£1,982	£2,036	£2,090
2600mm	£1,748	£1,777	£1,806	£1,836	£1,866	£2,002	£2,057	£2,111	£2,165

Drop	2,600mm	2,800mm	3,000mm	3,200mm	3,400mm	3,600mm	3,800mm	4,000mm	4,200mm
600mm	£1,774	£1,817	£1,859	£1,899	£1,941	£1,983	£2,025	£2,067	£2,109
1000mm	£1,831	£1,874	£1,916	£1,956	£1,998	£2,040	£2,082	£2,124	£2,165
1400mm	£1,890	£1,933	£1,975	£2,016	£2,057	£2,099	£2,141	£2,183	£2,225
1800mm	£2,126	£2,180	£2,234	£2,288	£2,342	£2,396	£2,450	£2,504	£2,558
2200mm	£2,144	£2,198	£2,252	£2,306	£2,360	£2,414	£2,468	£2,522	£2,576
2600mm	£2,219	£2,273	£2,327	£2,381	£2,435	£2,489	£2,543	£2,597	£2,651

Drop	4,400mm	4,600mm	4,800mm	5,000mm
600mm	£2,151	£2,192	£2,233	£2,275
1000mm	£2,207	£2,249	£2,290	£2,331
1400mm	£2,267	£2,309	£2,349	£2,391
1800mm	£2,612	£2,668	£2,720	£2,774
2200mm	£2,630	£2,685	£2,738	£2,792
2600mm	£2,705	£2,761	£2,813	£2,867



Manual Underblinds

Projection	Width						
	1000	1500	2000	2500	3000	3500	4000
1000	£428	£456	£485	£513	£828	£856	£885
1250	£441	£470	£498	£527	£841	£870	£898
1500	£454	£483	£512	£540	£854	£883	£912
1750	£468	£496	£525	£554	£868	£896	£925
2000	£481	£510	£538	£567	£881	£910	£938
2250	£494	£523	£552	£580	£895	£923	
2500	£508	£536	£565	£594	£908	£937	
2750	£521	£550	£578	£607	£1,079		
3000	£534	£563	£592	£620	£1,079		



Delivery charges apply if delivered separate to veranda. Prices are exclusive of VAT.

Sliding *Glass Doors*

NO DISCOUNT APPLIES TO THIS SECTION

LENGTH (M)	HEIGHT (M)				
	2.1	2.2	2.3	2.4	2.5
2.4	£1,194	£1,212	£1,231	£1,249	£1,269
2.9	£1,302	£1,326	£1,345	£1,367	£1,392
3.4	£1,467	£1,493	£1,517	£1,541	£1,568
3.9	£1,751	£1,777	£1,806	£1,832	£1,940
4.4	£1,819	£1,852	£1,882	£1,912	£2,061
4.9	£1,928	£1,961	£1,995	£2,030	£2,141
5.4	£1,997	£2,034	£2,071	£2,108	£2,158
5.9	£2,069	£2,108	£2,145	£2,185	£2,225

LENGTH (M)	HEIGHT (M)				
	2.1	2.2	2.3	2.4	2.5
2.4	£2,182	£2,201	£2,221	£2,239	£2,258
2.9	£2,291	£2,313	£2,335	£2,356	£2,380
3.4	£2,587	£2,613	£2,636	£2,661	£2,686
3.9	£2,869	£2,894	£2,925	£2,950	£2,979
4.4	£3,203	£3,235	£3,265	£3,295	£3,324
4.9	£3,312	£3,346	£3,377	£3,412	£3,444
5.4	£3,524	£3,562	£3,600	£3,637	£3,670
5.9	£3,598	£3,637	£3,674	£3,713	£3,753

The above prices is **WITHOUT** TOP Frames

The above prices is **WITH** TOP Frames

Price is per opening between posts

Guide for installation times

1 day - Sides Only

2 days - Sides & Front

Prices reflect the standard colour range for your chosen system.

Additional Uplift for non-standard RAL - POA

TRADE PRICES INCLUDE THE FOLLOWING:

- 8mm toughened glass
- Polishing & drilling
- Locks and fixings

TRADE PRICES DO NOT INCLUDE THE FOLLOWING:

- VAT

Example below:

WITHOUT TOP FRAME

9m x 3.5m = 3 sets @ 2.1m high 2.9m wide = £1302 x 3 = £3906

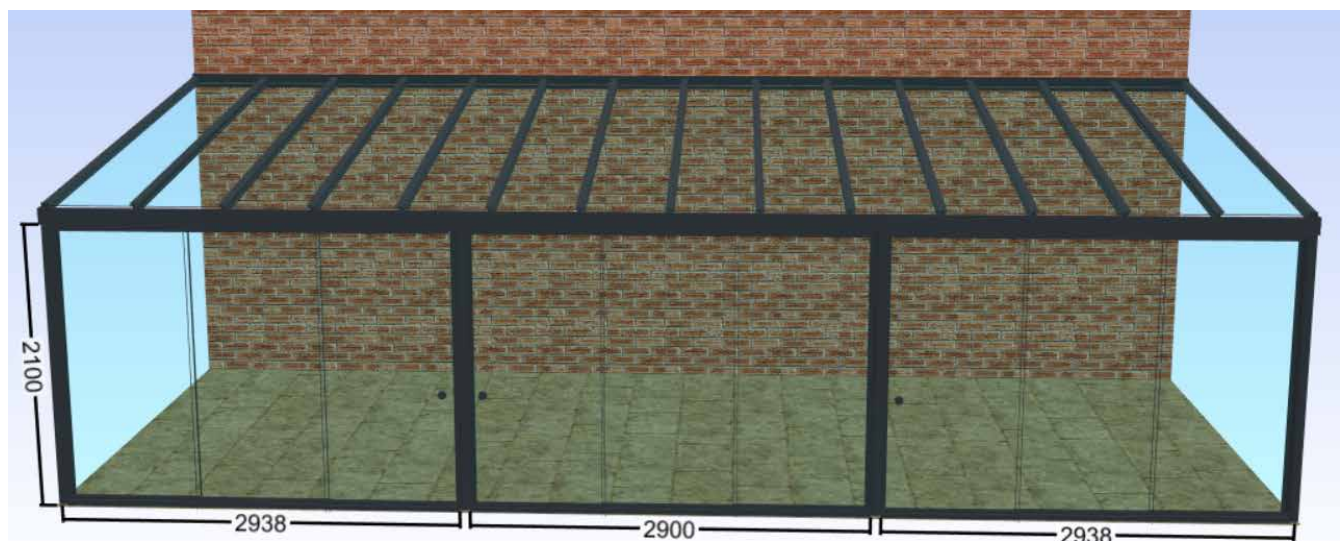

Double Glazed *Side & Front Frames*

Top Frames ONLY

NO DISCOUNT APPLIES

If you are looking to purchase individual Top Frames ONLY please reference the table below

LENGTH (M)					
1	2	3	4	5	6
£816	£984	£1,320	£1,440	£1,800	£1,920
Price Includes		Aluminium Frames		28mm Sealed Glass Units	
			Gaskets	Trims	

Fixed Glass Side & Front Panels

NO DISCOUNT APPLIES

Our aluminium framed fixed glass panels are supplied fully double glazed and finished to our standard RAL colours.

- Please note all Fixed Side and Front Frames are supplied at a maximum Height of 2.4m
- Any Fixed Side Angled Frames with a back height of OVER 2.4m will require an additional TOP FRAME to complete the top section

SIDE BY SIDE FRAME (LENGTH)	METRES					
	1	2	3	4	5	6
28mm Glass Units Clear Glass	£792	£1,344	£1,920	£2,520	£3,120	£3,720
28mm Glass Units Tinted Grey/ Bronze/Frosted	POA	POA	POA	POA	POA	POA



Single Glazed Fixed *Side & Front Frames*

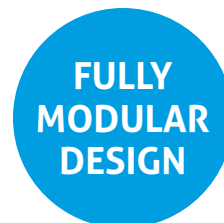

NO DISCOUNT APPLIES TO THIS SECTION

Fixed Side and Front Frames

Our Top Frames/Wedge aluminium framed fixed glass panels are supplied fully assembled, unless stated otherwise.

All other rectangular and shaped full frames are supplied dismantled for site assembly.

All full frames consist of 8.8mm laminated glass. All cheese frames will consist of 6mm toughened glass.

Frames arrive with the relevant beading with glass and gasket supplied loose.

Installation is easy with just removal of the bead required, insert the glass and apply the gasket.

(Gasket will need trimming to suit the 8.8mm glass on-site).

Size Parameters:

- Length: Max 6m
- Height: Max 2.8m (Anything over 2.8m must be a square frame and wedge)
- Maximum panel size is no more than 5m squared
- Laminated glass is 8.8mm thick in the full frame and 6mm thick in the cheese frame
- Weight of glass is 22kg per sq m
- If additional panels are required to the set ones above then this is POA
- If a cheese frame and full frame is needed to match with panel alignment then they can be designed that way at CAD stage

Frame Colour Options:

- RAL9016 White (Semi Gloss)
- RAL7016 Anthracite Grey Fine Textured
- RAL9005 Jet Black Fine Textured

Other RAL colours available at 20% extra.

Top Frames/Wedges

(Up to 1m back height – anything over is POA)

LENGTH	NO. OF PANELS	CLEAR GLASS
1m	1	£617.00
2m	1	£765.00
3m	2	£902.00
4m	2	£1,023.00
5m	3	£1,210.00
6m	3	£1,360.00

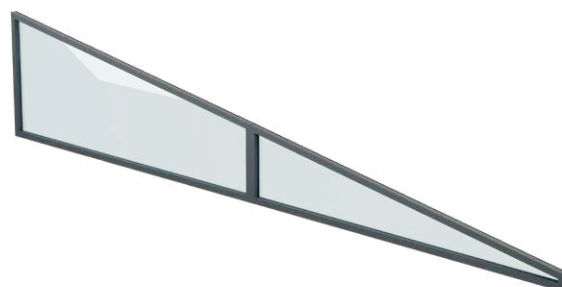

Cheese Frame Glass Room



Shaped and Rectangular Frames

(Up to 2.4m)

LENGTH	NO. OF PANELS	CLEAR GLASS SHAPED	CLEAR GLASS RECTANGULAR
1m	1	£964.00	£838.00
2m	2	£1,463.00	£1,447.00
3m	2	£1,795.00	£1,625.00
4m	3	£2,289.00	£2,090.00
5m	4	£2,785.00	£2,557.00
6m	5	£3,322.00	£3,060.00

Full Frame Veranda

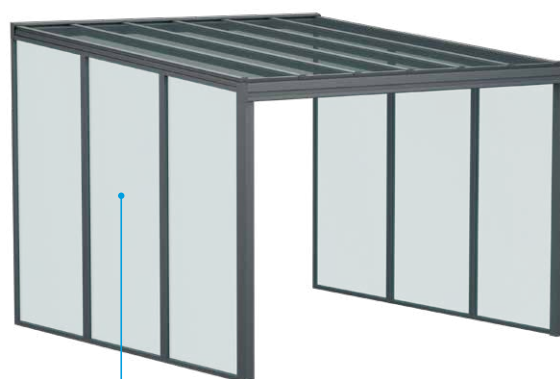

Shaped Frame Panels

Shaped and Rectangular Frames

(Up to 2.8m)

LENGTH	NO. OF PANELS	CLEAR GLASS SHAPED	CLEAR GLASS RECTANGULAR
1m	1	£1,236.00	£1,034.00
2m	2	£1,816.00	£1,600.00
3m	2	£2,194.00	£1,926.00
4m	3	£2,770.00	£2,457.00
5m	4	£3,351.00	£2,988.00
6m	5	£3,979.00	£3,556.00

Side or Front Frame Panel



Shaped Frame

Side or Front Frame Panels x3

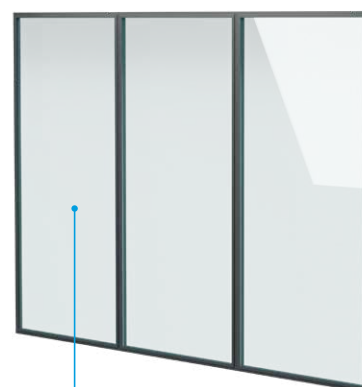

Rectangular Frame

Export Delivery Costs

Should your order be a product we Import (see list below) or your Order needs to be exported then the following additional costs will be applicable:

Export Costs

Bespoke Crate containing profiles and glass
4M = £500.00; 5M = £550.00; 6M = £600.00

Bespoke Crate containing profiles and Poly
4M = £500.00; 5M = £550.00; 6M = £600.00

Bespoke Crate containing profiles ONLY
4M = £125.00; 5M = £150.00; 6M = £175.00

Collection Option

You do have the option to collect your order from our manufacturing facility in Hinckley Leicestershire LE10 3BS.

If you elect to do this then none of the above Export costs apply, however Import costs are still applicable.

You need to ensure you have adequate means of transporting potentially 6m long profiles and sheets of 6mm or 8mm glass.



Delivery Prices

PRICES BELOW AS OF JUNE 2024

- ZONE 1 = FOC
- ZONE 2 = FOC
- ZONE 2A = £350
- ZONE 2B = £350
- ZONE 3 = £200
- ZONE 4 = £200
- ZONE 5 = POA -
Lowlands Scotland
- ZONE 6 = POA
- ZONE 7 = POA

Please note: The above prices are based on a standard delivery; they do not include offloading. When a Moffit or Hiab vehicle is required, please be aware that this will incur additional costs and will need to be quoted at POA.

Assisted delivery = £100 +VAT

All prices are subject to VAT.

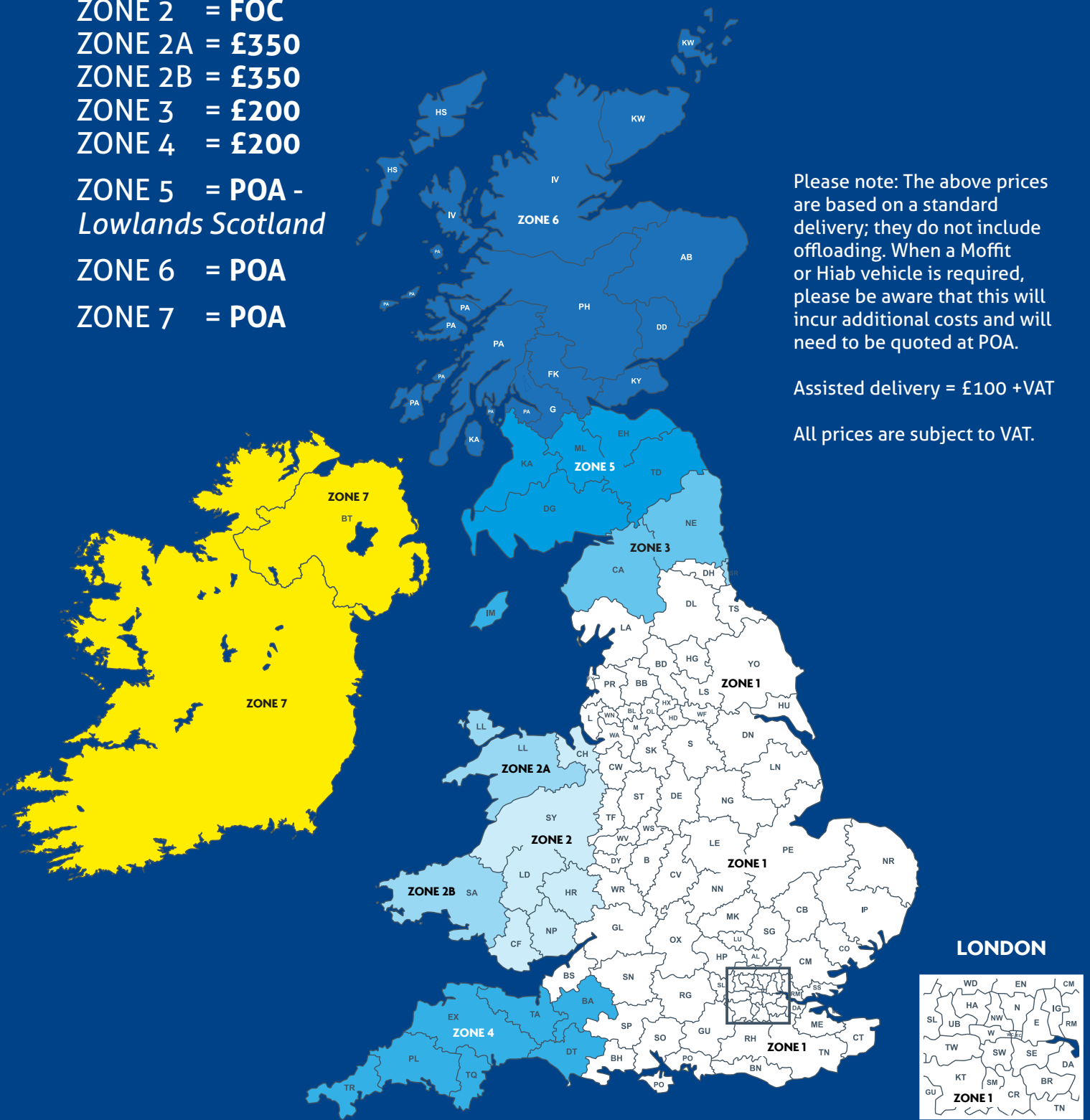

Offering an extensive range of
outdoor living products



0333 305 5272 | sales@milwoodgroup.com

Manufacturing, Showroom and Training

Europa & Jenner House, Victory Park, 1-2 Trident Close, Medway City Estate, Rochester, ME2 4ER

Manufacturing address:

8 Jacknell Road, Dodwells Bridge Industrial Estate, Hinkley, LE10 3BS

www.milwoodgroup.com